

NERC Staff Organization Chart 2015 Budget

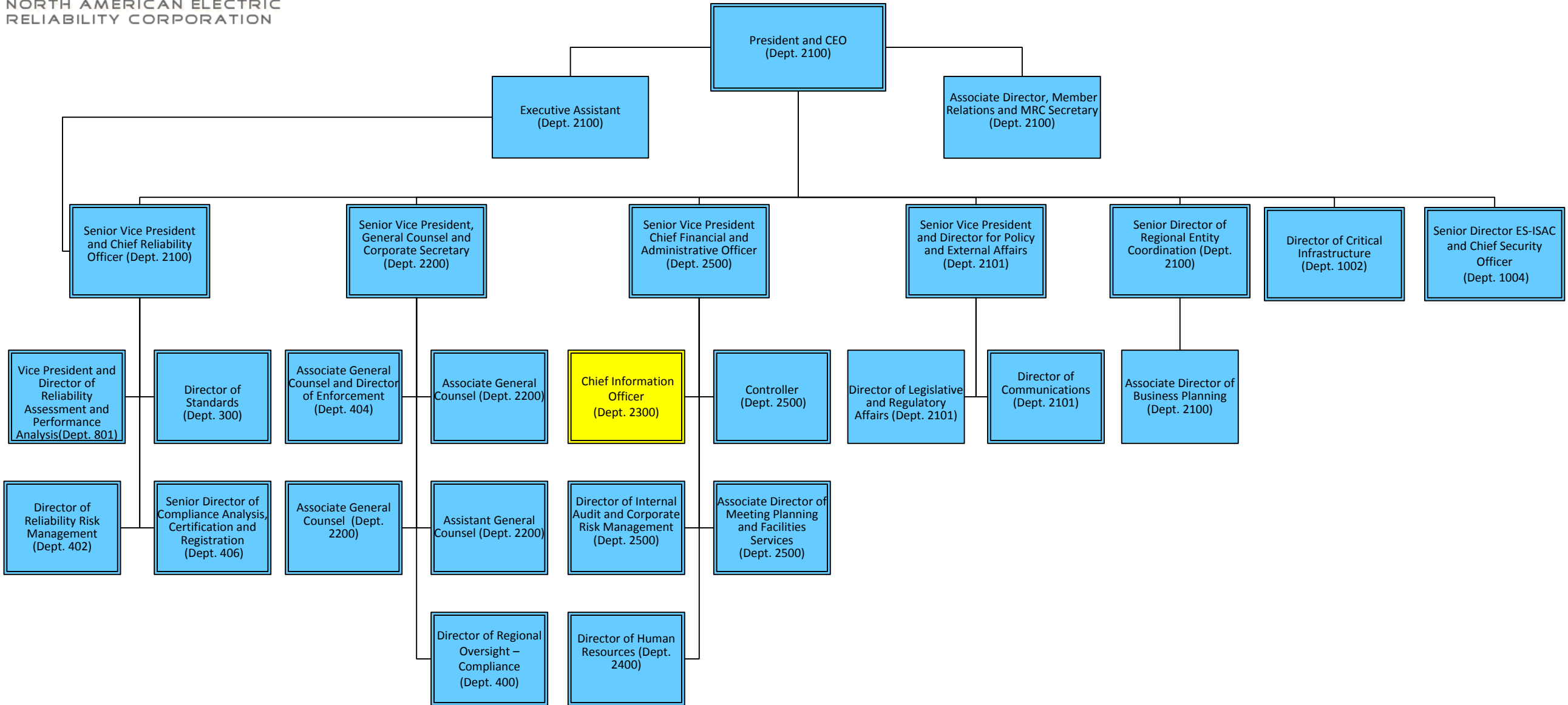

Reliability Standards 2015 (Dept. 300)

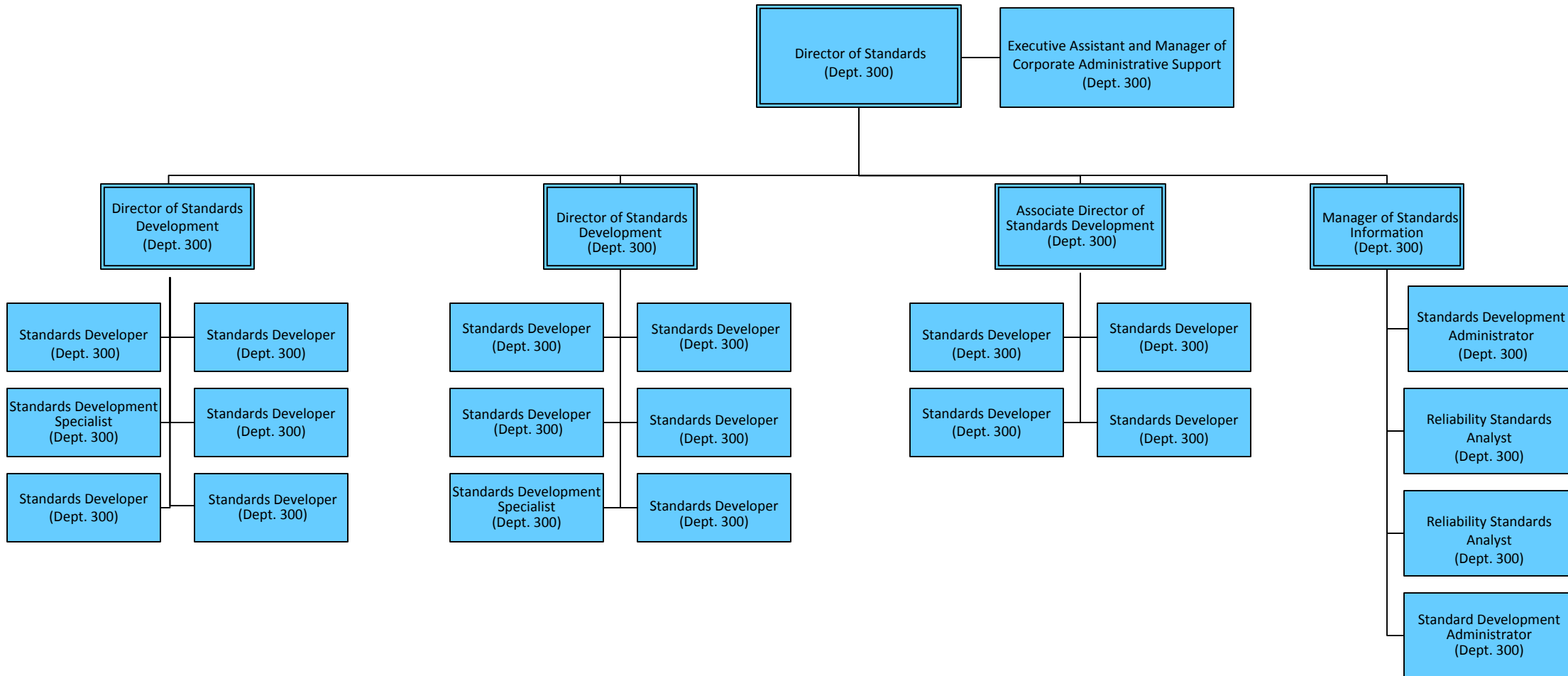

Compliance Analysis, Certification and Registration 2015 (Dept. 406, 500)

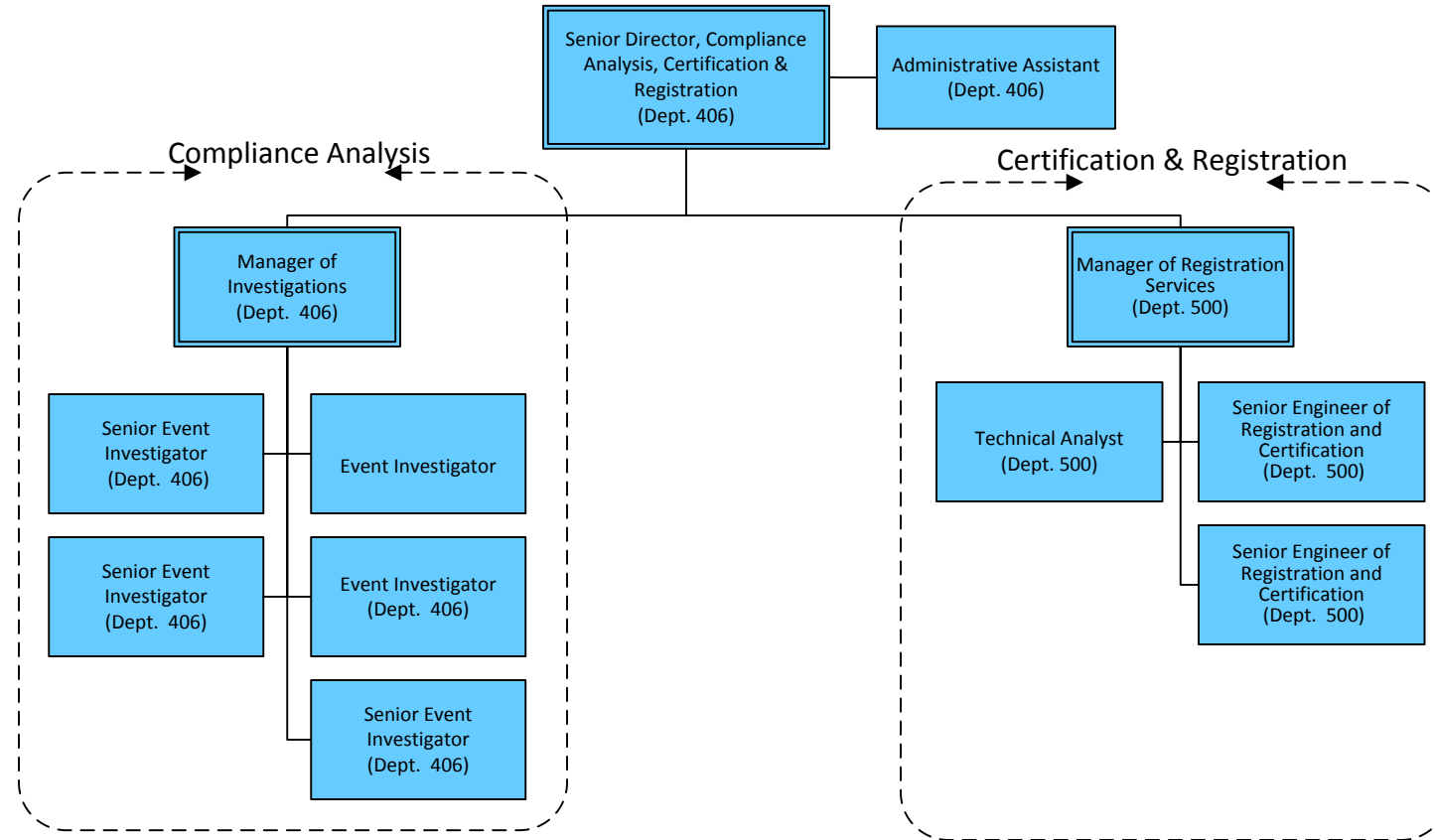

Regional Oversight - Compliance 2015 (Dept. 400)

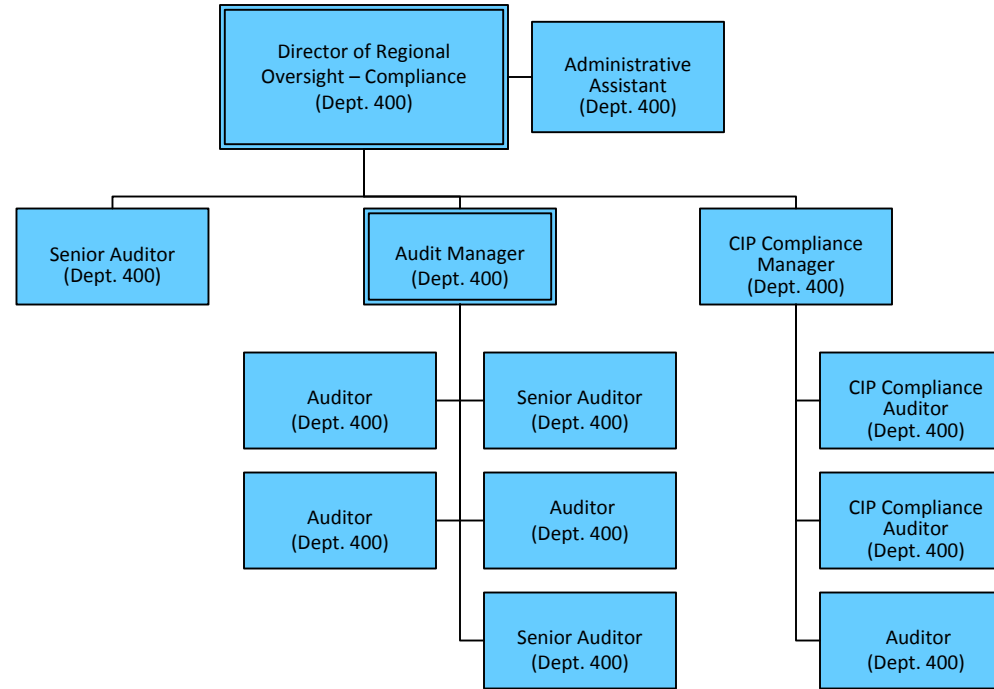

Compliance Enforcement 2015 (Dept. 404)

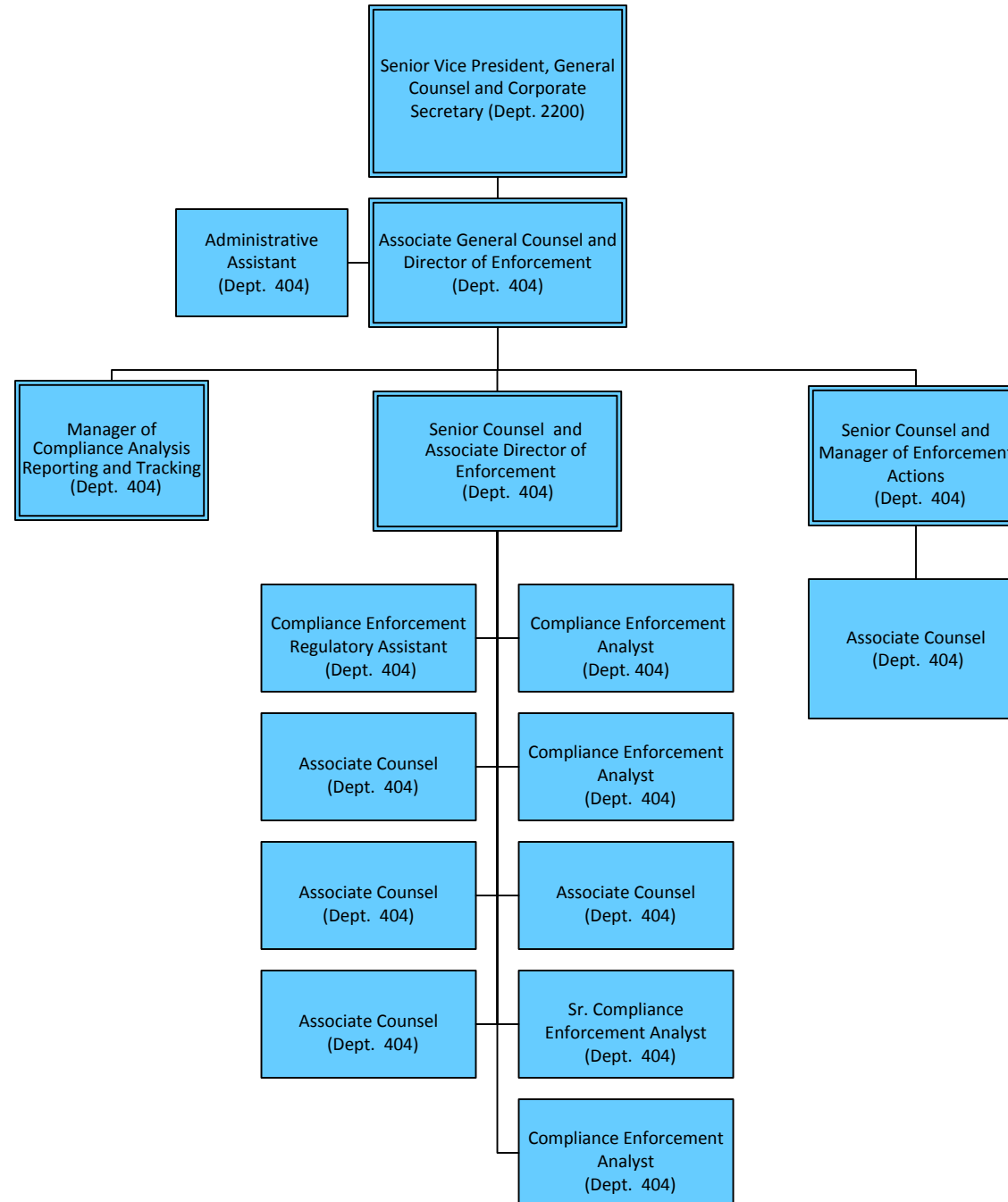

Reliability Assessment and Performance Analysis 2015 (Dept. 801)

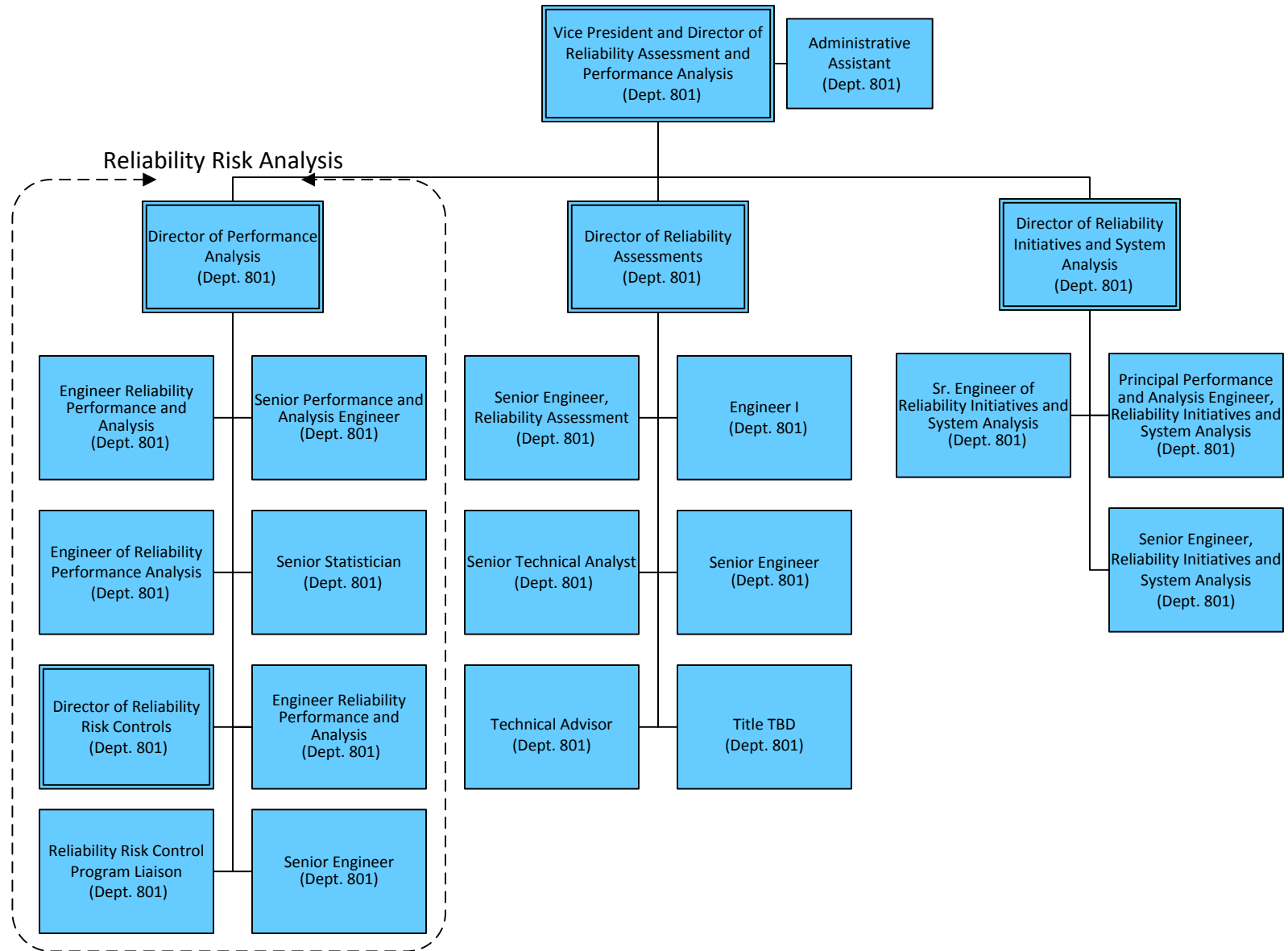

Reliability Risk Management 2015 (Dept. 402, 600, 900, 1001)

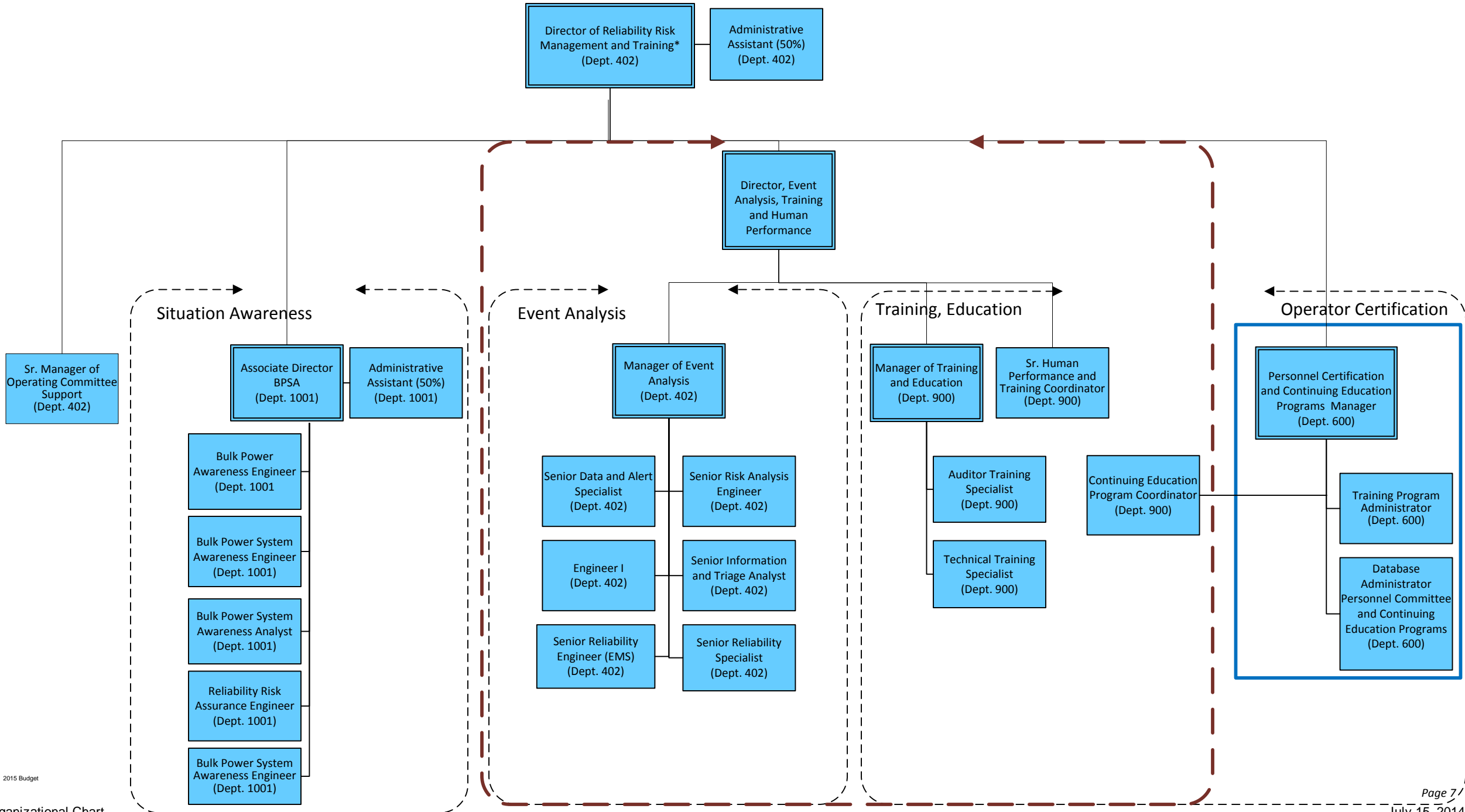

Critical Infrastructure Department 2015 (Dept. 1002)

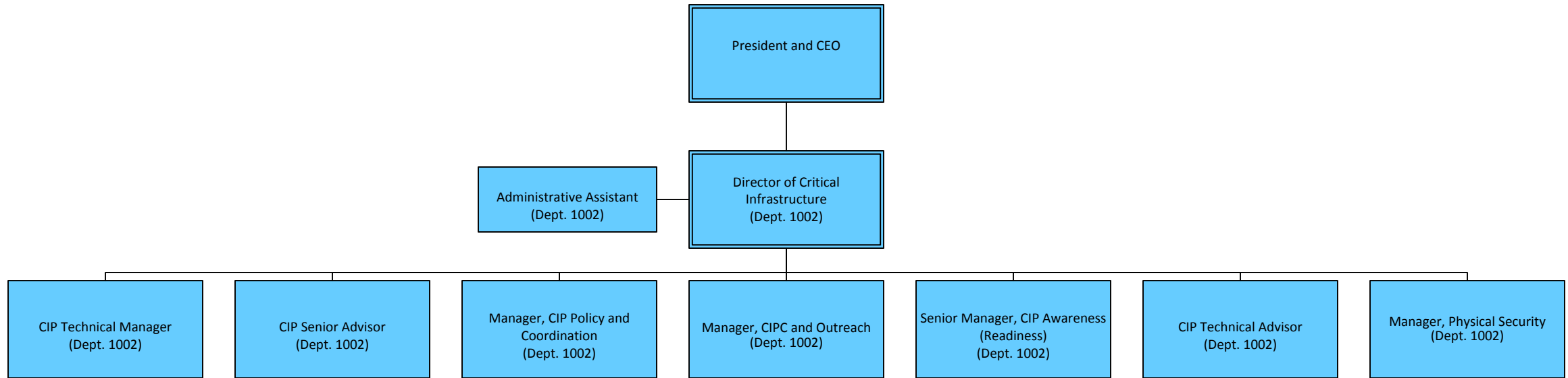

ES-ISAC 2015 (Dept. 1004)

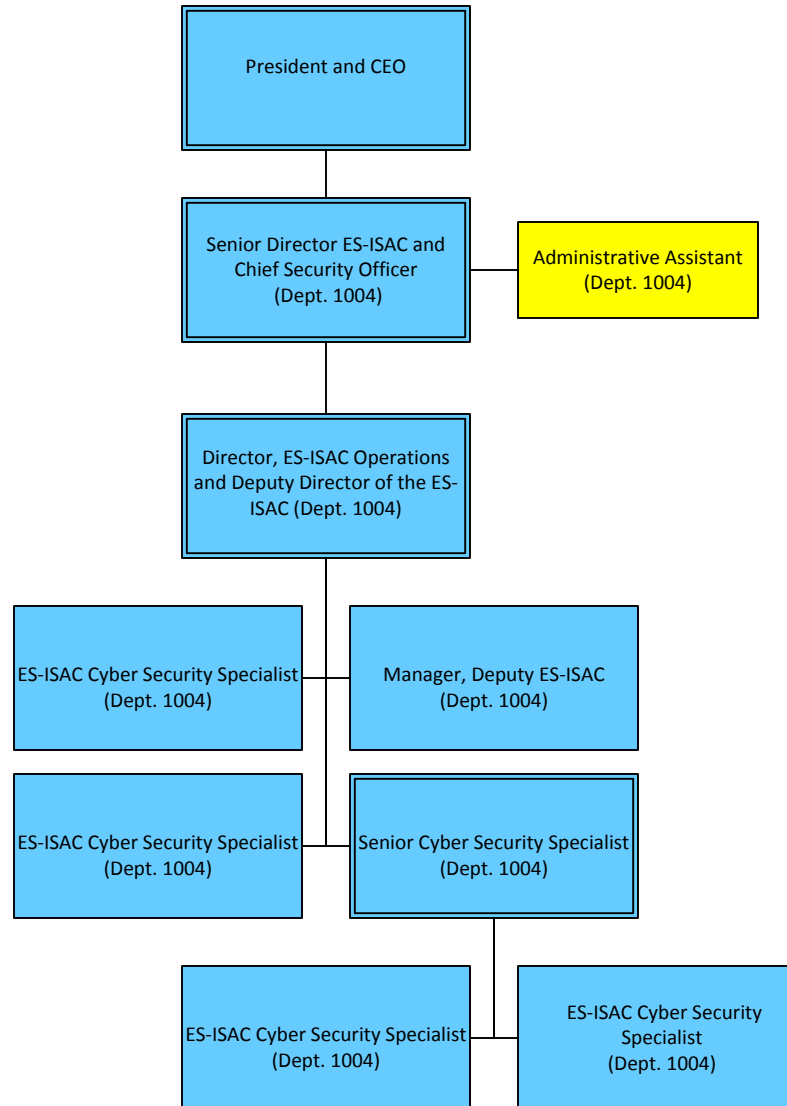

Legal and Regulatory 2015 (Dept. 2200) Compliance Enforcement 2015 (Dept. 404)

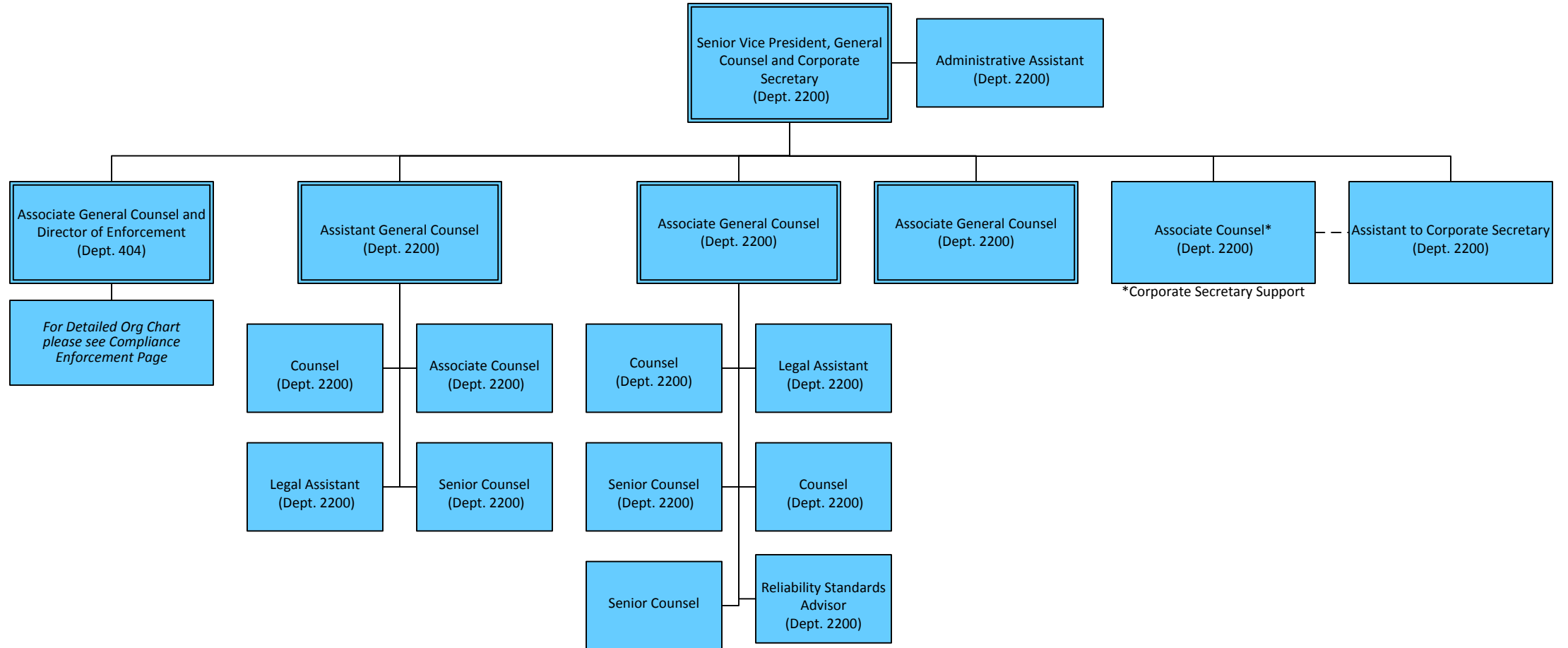

Policy and External Affairs 2015 (Dept. 2101)

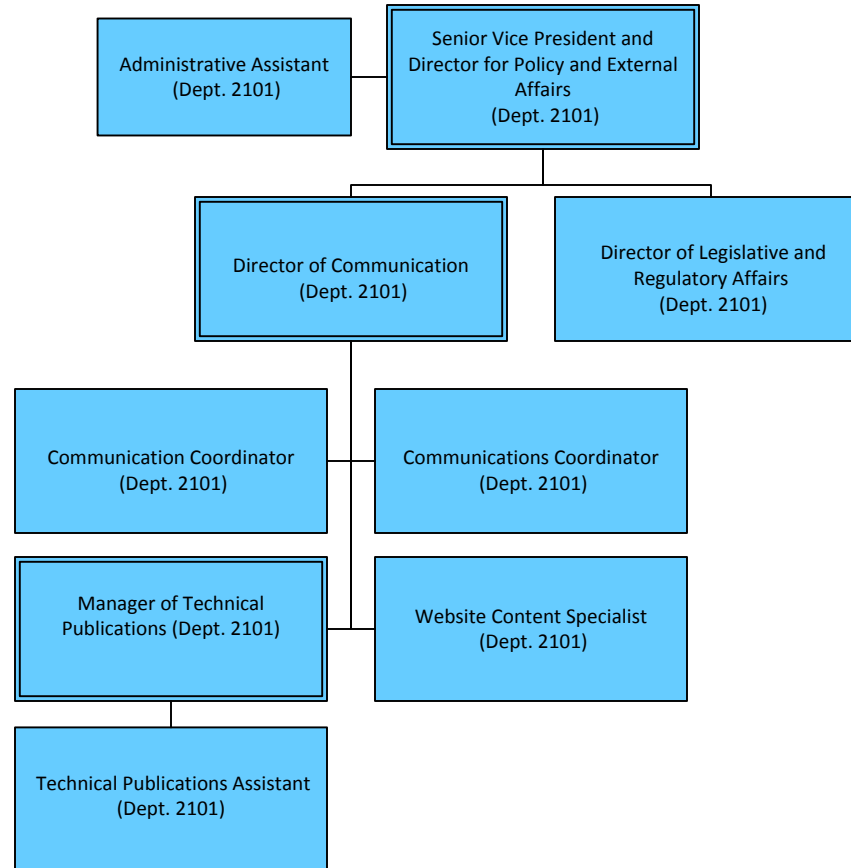

2015 Budget

Human Resources, Accounting & Finance and Information Technology 2015 (Dept. 2300, 2400, 2500)

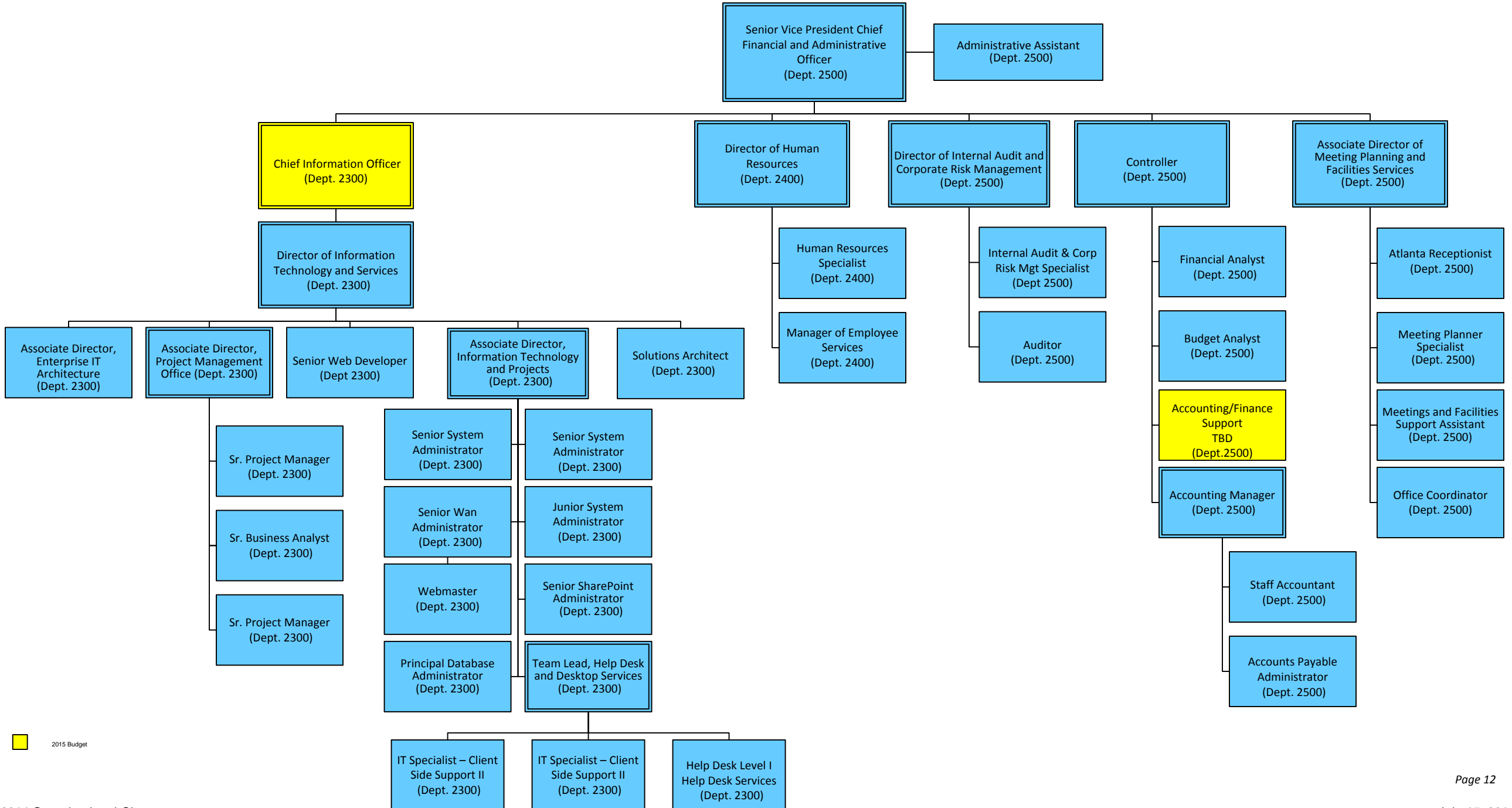

2015 Budget